

KING



Jasper Outdoor II Woven
Components | Packages

kingliving.com

DT12020112V1

Jasper Outdoor II Woven Components | General Dimensions

Woven Arm/Back

W260 (10.25") H290 (11.5")

A78



780 (30.75")

A156



1560 (61.5")

A104



1040 (41")

A208



2080 (82")

Woven Shelves

W260 (10.25") H290 (11.5")

T78 Woven Shelf



780 (30.75")

T104 Woven Shelf



1040 (41")

Back Cushions

H500 (19.75")

B78



780 (30.75")

B104



1040 (41")

Woven Storage* Base STD

D1040 (41") H470 (18.5")

Base 182 S156 RH



1820 (71.75")

Base 182 S156 LH

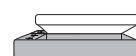

1820 (71.75")

Base 234 S208 RH



2340 (92.25")

Base 234 S208 LH



2340 (92.25")

Storage* Base: Access Narrow End
(right-hand options with Arm/Back)



208D S104 RH | 182 S78 RH



Storage* Base: Access Wide End
(left-hand options with Arm/Back)



234 S208 LH



182 S156 LH

Base 182 S78 RH

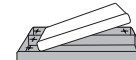

1820 (71.75")

Base 182 S78 LH

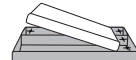

1820 (71.75")

Front General Heights

Standard | Deep Base (various widths)

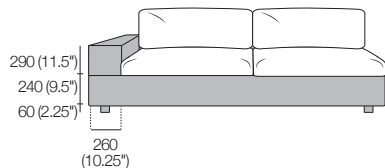

Side Depth / Height

STD Base

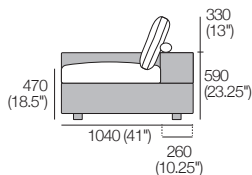

Side Depth / Height

Deep Base

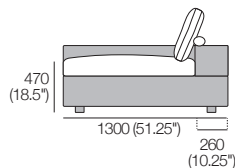

Woven Storage* Base Deep

D1300 (51.25") H470 (18.5")

Base 208D S104 RH



2080 (82")

Base 208D S104 LH

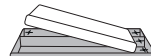

2080 (82")

Effective August 2021. Woven Storage Bases, Arms/Backs, and Shelves available in selected KingRope™ LuxeW colours. *Storage area (unsealed) allows air to flow, and is suitable for stowing weather-proof items. As King Living has a policy of continuous improvement, changes to products and specifications may be made without prior notice. Images and component drawings shown are representative of design only. Accessories not included.

Jasper Outdoor II Woven

Components | Packages End Plus Ottoman | Daybed

Ottoman 104 S104

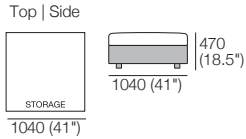

Ottoman 104 S78

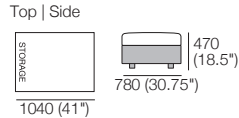

Reclining Sunlouge

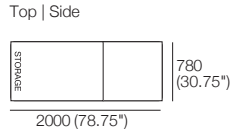

Base 182 DB S78

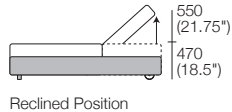
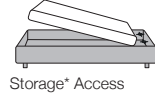
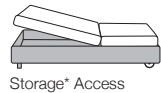
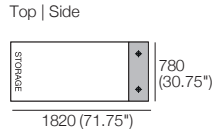

Package: 2 STR End SLH plus Ottoman

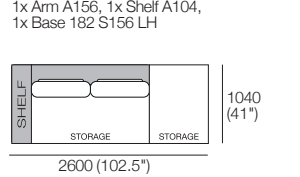

Package: 2 STR End SRH plus Ottoman

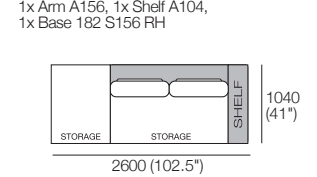

Package: 3 STR End SLH plus Ottoman

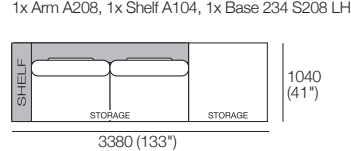

Package: 3 STR End SRH plus Ottoman

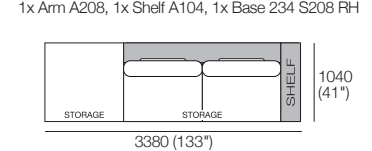

Package: DayBed 182 S78

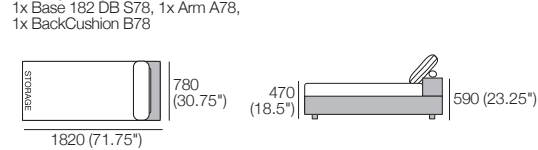

Jasper Outdoor II

Packages A1 | B

Package A1 SLH

1x Base 234 S208 RH, 1x Base 208D S104 LH,
1x Arm A208, 2x Arm A104, 2x Shelf A104,
3x BackCushion B104

Configurations:

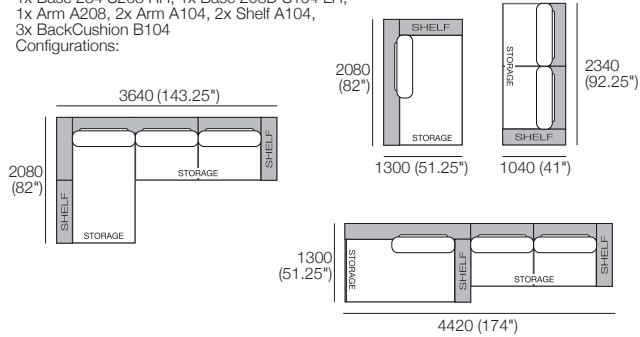

Package A1 SRH

1x Base 208D S104 RH, 1x Base 234 S208 LH,
1x Arm A208, 2x Arm A104, 2x Shelf A104,
3x BackCushion B104

Configurations:

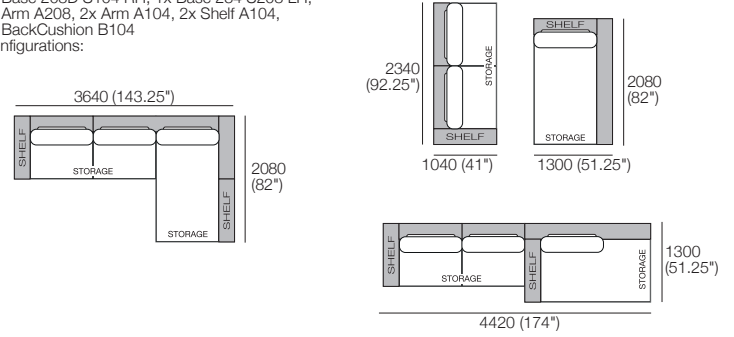

Package B SLH

1x Base 182 S78 LH, 1x Base 182 S156 RH, 1x Arm A156,
1x Arm A104, 1x Arm A78, 1x Shelf A104,
1x Shelf A78, 3x BackCushion B78

Configurations:

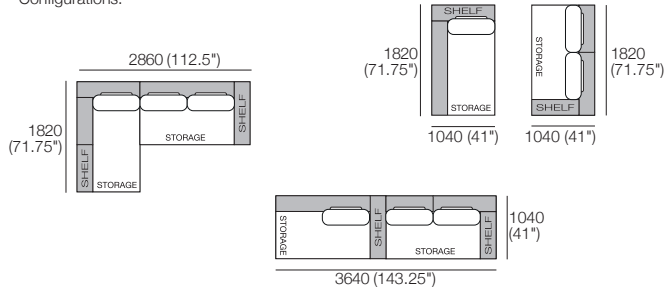

Package B SRH

1x Base 182 S78 RH, 1x Base 182 S156 LH, 1x Arm A156,
1x Arm A104, 1x Arm A78, 1x Shelf A104,
1x Shelf A78, 3x BackCushion B78

Configurations:

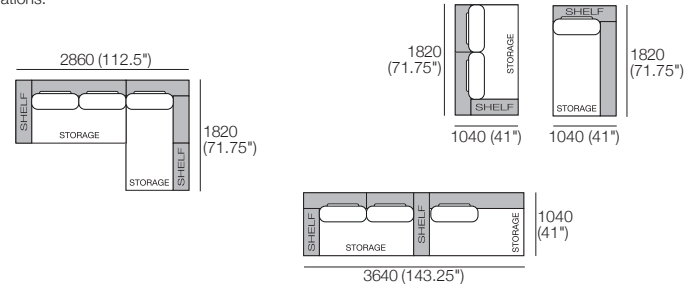

KING



Jasper Outdoor II
Packages A1 Grand | C

DT2020149 VI
kingliving.com

Jasper Outdoor II

Package A1 Grand SLH

Package A1 Grand SLH

1x Base 234 S208 RH, 1x Base 208D S104 LH, 1x Arm A208, 2x Arm A104, 2x Shelf A104,
 3x BackCushion B104, 1x Ottoman 104 S104, 1x Ottoman 104 S78
 Configurations:

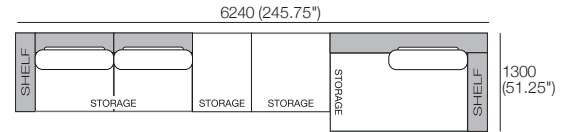
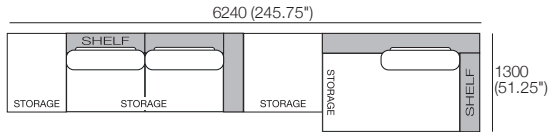
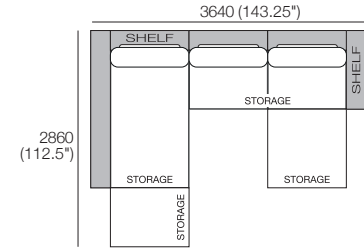
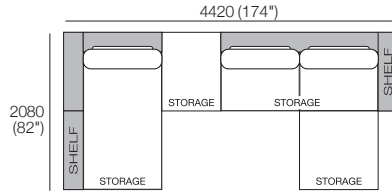
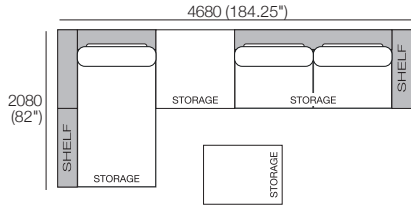
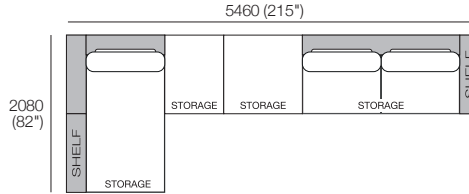
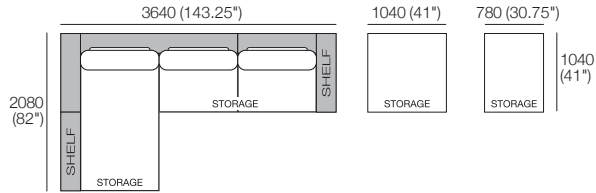

*RH base reconfigured to LH base

Effective August 2021. Woven Storage Bases, Arms/Backs, and Shelves available in selected KingRope LuxeW colours. *Storage area (unsealed) allows air to flow, and is suitable for stowing weather-proof items. As King Living has a policy of continuous improvement, changes to products and specifications may be made without prior notice. Images and component drawings shown are representative of design only. Accessories not included.

Jasper Outdoor II

Package A1 Grand SRH

Package A1 Grand SRH

1x Base 234 S208 LH, 1x Base 208D S104 RH, 1x Arm A208, 2x Arm A104, 2x Shelf A104,
3x BackCushion B104, 1x Ottoman 104 S104, 1x Ottoman 104 S78

Configurations:

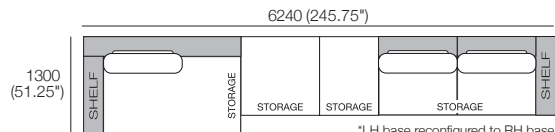
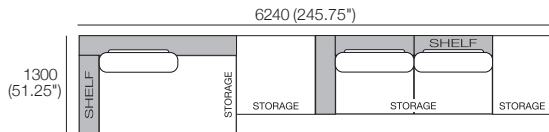
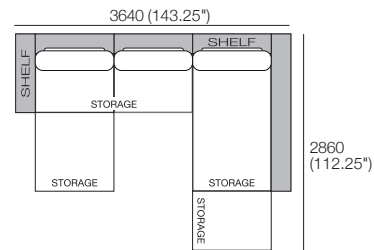
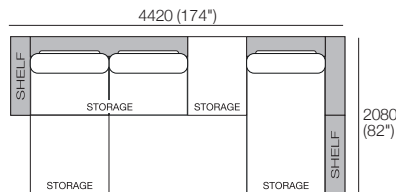
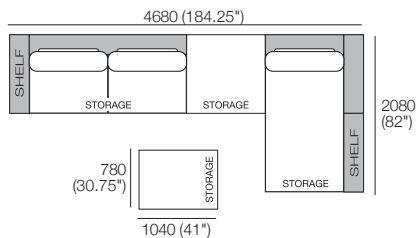
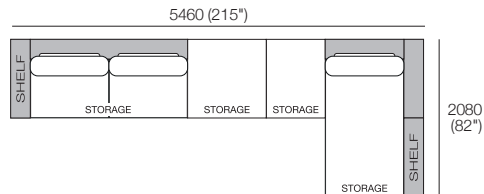
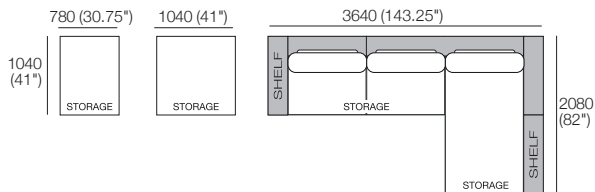

*LH base reconfigured to RH base

Effective August 2021. Woven Storage Bases, Arms/Backs, and Shelves available in selected KingRope LuxeW colours. *Storage area (unsealed) allows air to flow, and is suitable for stowing weather-proof items. As King Living has a policy of continuous improvement, changes to products and specifications may be made without prior notice. Images and component drawings shown are representative of design only. Accessories not included.

Jasper Outdoor II

Package C

Package C

1x Base 182 S156 LH, 1x Base 182 S156 RH, 1x Arm A156, 2x Arm A78, 2x Shelf A104,
 4x Back Cushion B78, 1x Ottoman 104 S104
 Configurations:

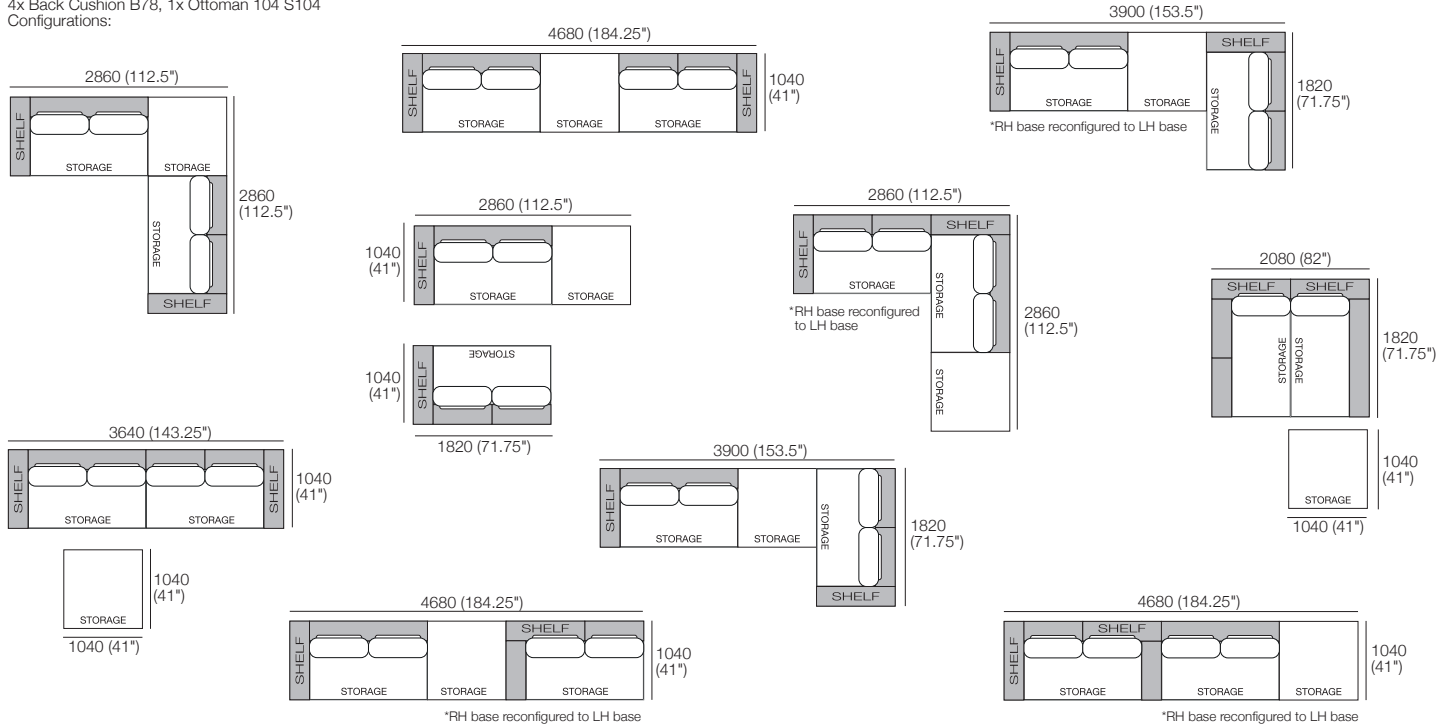

Effective August 2021. Woven Storage Bases, Arms/Backs, and Shelves available in selected KingRope LuxeW colours. *Storage area (unsealed) allows air to flow, and is suitable for stowing weather-proof items. As King Living has a policy of continuous improvement, changes to products and specifications may be made without prior notice. Images and component drawings shown are representative of design only. Accessories not included.

KING



Jasper Outdoor II
Packages B Plus Ottoman

DT2020149 V1
kingliving.com

Jasper Outdoor II Packages

B SLH Plus Ottoman S104 | B SLH Plus Ottoman S78

Package B SLH Plus Ottoman S104

1x Base 182 S78 LH, 1x Base 182 S156 RH, 1x Arm A156, 1x Arm A104, 1x Arm A78, 1x Shelf A104, 1x Shelf A78, 3x BackCushion B78, 1x Ottoman S104

Configurations:

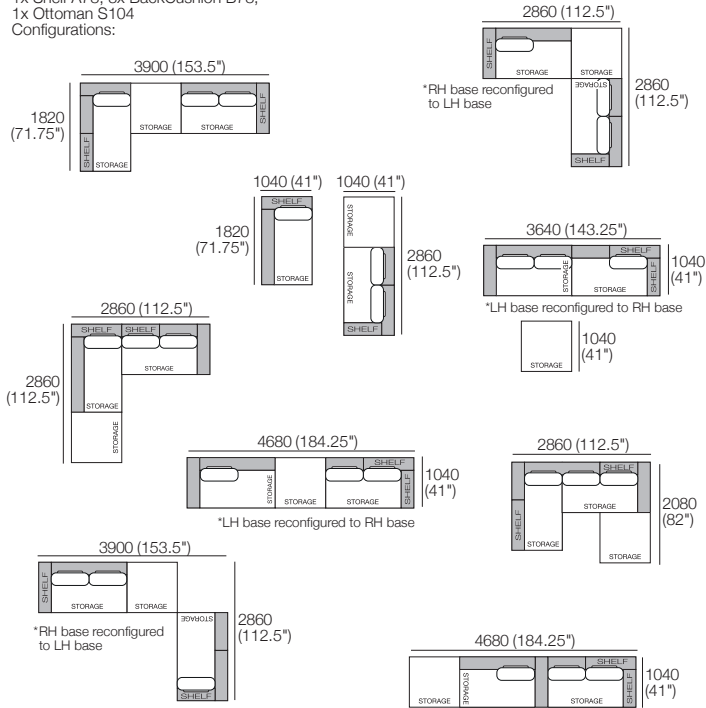

Package B SLH Plus Ottoman S78

1x Base 182 S78 LH, 1x Base 182 S156 RH, 1x Arm A156, 1x Arm A104, 1x Arm A78, 1x Shelf A104, 1x Shelf A78, 3x BackCushion B78, 1x Ottoman S78

Configurations:

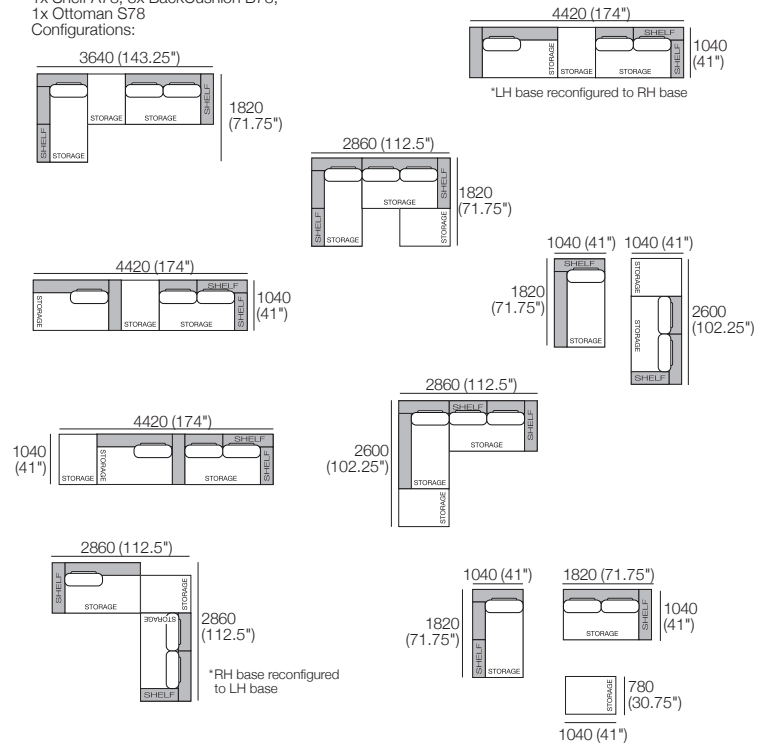

Effective August 2021. Woven Storage Bases, Arms/Backs, and Shelves available in selected KingRope LuxeW colours. *Storage area (unsealed) allows air to flow, and is suitable for stowing weather-proof items. As King Living has a policy of continuous improvement, changes to products and specifications may be made without prior notice. Images and component drawings shown are representative of design only. Accessories not included.

Jasper Outdoor II Packages

B SRH Plus Ottoman S104 | B SRH Plus Ottoman S78

Package B SRH Plus Ottoman S104

1x Base 182 S78 RH, 1x Base 182 S156 LH, 1x Arm A156,
1x Arm A104, 1x Arm A78, 1x Shelf A104,
1x Shelf A78, 3x BackCushion B78,
1x Ottoman S104

Configurations:

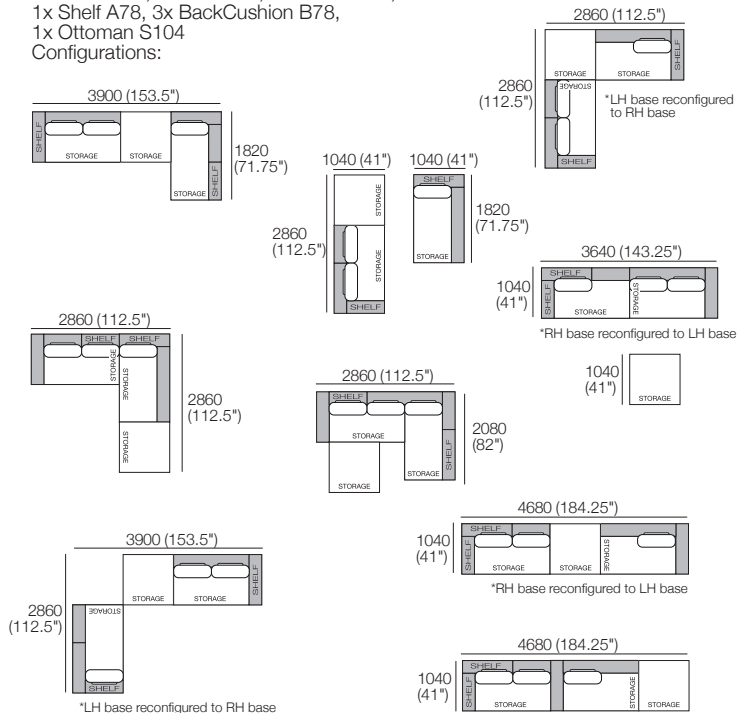

Package B SRH Plus Ottoman S78

1x Base 182 S78 RH, 1x Base 182 S156 LH, 1x Arm A156,
1x Arm A104, 1x Arm A78, 1x Shelf A104,
1x Shelf A78, 3x BackCushion B78,
1x Ottoman S78

Configurations:

